



ÍNDICE INDEX

03 - Pavimento SOLID CLICK XL

SOLID CLICK XL flooring

Revêtement de sol SOLID CLICK XL

04 - Cores SOLID CLICK XL

SOLID CLICK XL colours

Couleurs SOLID CLICK XL

18 - Ficha técnica SOLID CLICK XL

SOLID CLICK XL Technical sheet

Fiche technique SOLID CLICK XL

20 - Rodapés WPC e madeira

WPC and wood skirtings

Plinthes en WPC et bois

21 - Rodapés de alumínio

Aluminium skirtings

Plinthes en aluminium

22 - Perfis de remate

Aluminium profiles

Profils en aluminium

28 - Telas de isolamento

Isolation underlays

Sous couches

30 - Cores disponíveis

Available colours

Couleurs disponibles

32 - Correspondência de padrões

Colours correspondence

Correspondance des motifs

APRESENTAÇÃO

PRESENTATION | PRÉSENTATION

A GS FLOORS é uma marca de pavimentos e revestimentos que apresenta soluções de qualidade distinta e disponibiliza uma vasta panóplia de artigos que aliam a resistência, o design e a funcionalidade.

Toda a coleção que compõe a marca GS FLOORS foi meticulosamente produzida de acordo com as necessidades mais exigentes, dando forma aos projetos mais desafiantes em ambientes residenciais e comerciais.

A gama GS FLOORS fica completa com os rodapés, perfis e telas de isolamento, de fácil aplicação e manutenção. Elementos imprescindíveis para conseguir a perfeita harmonia estética.

O foco no cliente, o apoio técnico especializado e a forma como valorizamos os espaços interiores são os princípios que mais prezamos e que fazem da GS FLOORS uma marca de confiança!

O design e o conforto aos seus pés!

(EN)

GS FLOORS is a high-quality range of floorings and coverings that offers a wide variety of products combining resistance, design and functionality.

The entire GS FLOOR collection was meticulously produced according to the most demanding needs, giving shape to the most challenging projects in residential and commercial environments.

The GS FLOORS range is completed with skirting boards, profiles and underlays, which are of easy installation and maintenance, essential elements to achieve the perfect aesthetic harmony.

The focus on the customer, the specialized technical support and the way we value housing spaces, are the principles we appreciate the most and that makes GS FLOORS a trusted brand!

Design and comfort at your feet!

(FR)

GS FLOORS est une marque de revêtements de sol qui présente des solutions d' haute qualité et propose une large gamme des produits alliant résistance, design et fonctionnalité.

L'ensemble de la collection qui compose la marque GS FLOORS a été méticuleusement fabriqué selon les besoins les plus exigeants, en donnant forme aux projets les plus ambitieux dans les environnements résidentiels et commerciaux.

La gamme GS FLOORS est complète avec des plinthes, des profils et des sous-couches, faciles d'installer et à entretenir. Ceux sont des éléments essentiels pour atteindre une parfaite harmonie esthétique.

L'accent mis sur le client, le support technique spécialisé et la façon dont nous valorisons les espaces intérieurs sont les principes que nous apprécions le plus et qui font de GS FLOORS une marque de confiance!

Le design et le confort à vos pieds!



Pag. 3-17



Pag.20



Pag. 21

PAVIMENTO VINÍLICO SPC

SPC VINYL FLOORING | PLANCHER DE VINYLE SPC

Solid  **CLICK XL**

A nova linha de pavimento vinílico SOLID CLICK XL foi desenvolvida com base nas mais avançadas tecnologias e traduz o perfeito equilíbrio entre o conforto e o design, combinando visuais de luxo com todos os benefícios do vinil.

Apresenta uma forte resistência à humidade, tratamento antibacteriano, uma estrutura multicamadas com núcleo rígido de grande estabilidade dimensional e um sistema de clique patenteado nos 4 topos. Permite um caminhar silencioso e confortável, elevando desta forma as potencialidades de um pavimento SPC. A régua é de grandes dimensões e já inclui tela de isolamento IXPE de 1,5 mm!

(EN)
The new SOLID CLICK XL vinyl flooring line was developed based on the most advanced technologies and reflects the perfect balance between comfort and design, combining luxury looks with all the benefits of vinyl.
It has a strong resistance to dampness, antibacterial treatment, a multilayer structure with a rigid core, a great dimensional stability and a patented 4 side click system. It allows a quiet and comfortable walking, elevating the potential of an SPC flooring. The plank is of a large dimension and already includes a 1,5 mm IXPE attached underlay!

(FR)
La nouvelle gamme de revêtements de sol en vinyle SOLID CLICK XL a été développée sur la base des technologies les plus avancées et traduit l'équilibre parfait entre confort et design, en alliant visuels de luxe avec tous les avantages du vinyle.
Il a une forte résistance à l'humidité, un traitement antibactérien, une structure multicouche avec un noyau rigide avec une grande stabilité dimensionnelle et un système de clic breveté sur les 4 coins. Il permet une marche silencieuse et confortable en élevant ainsi le potentiel du revêtements de sol SPC. La planche est de grande dimension et comprend déjà une sous couche IXPE de 1,5 mm!

COMPOSIÇÃO DA RÉGUA

PLANK COMPOSITION | COMPOSITION DE LAME

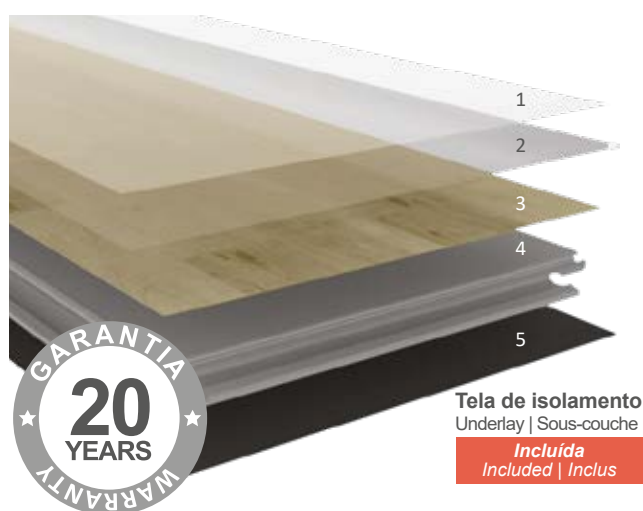







LEGENDA | LEGEND | LÉGENDE

- 1 Camada protetora PROTECTION PLUS tratamento anti-manchas e proteção UV**
PROTECTION PLUS Protective layer anti-stain treatment and UV protection
Couche de protection PROTECTION PLUS traitement anti-taches et protection UV
- 2 Camada de desgaste - 0,7 mm**
Clear wear layer - 0,7 mm
Couche d'usure - 0,7 mm
- 3 Filme impresso em alta qualidade e definição**
HD design print layer
Feuille décor d'impression HD
- 4 Núcleo rígido do SPC (sem orto-ftalato)**
Rigid SPC Core (Ortho-phthalates)
Noyau SPC rigide (sans ortho-phthalate)
- 5 Tela de IXPE 1,5 mm**
IXPE underlay 1,5 mm
Sous-couche IXPE 1,5mm

CARATERÍSTICAS

CHARACTERISTICS | CARACTÉRISTIQUES

-  **Ultra resistência à humidade**
Ultra moisture resistant
Ultra résistant à l'humidité
-  **Estabilidade dimensional**
Dimensional stability
Stabilité dimensionnelle
-  **Compatível com piso de aquecimento radiante**
Suitable for heated floor
Compatible avec des sols chauffants
-  **Camada de proteção UV e anti manchas**
UV and anti-stain protection coating
Couche de protection UV et anti-taches
-  **Acabamento extra mate**
Extra matt finish
Finition extra mate
-  **Sistema multicamadas para uma densidade mais forte**
Multi dimensional system for a stronger density
Système multicouche par une densité plus forte

DIMENSÃO DA RÉGUA: 1524 x 230 x 6,5 mm
PLANK DIMENSION: 1524 x 230 x 6,5 mm
DIMENSION DE LA LAME: 1524 x 230 x 6,5 mm

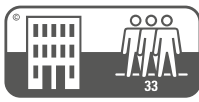
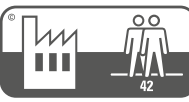
-  **Doméstico intenso**
Intense domestic
Domestique intense
-  **Comercial intenso**
Intense commercial
Commercial intense
-  **Industrial geral**
General industrial
Commercial intense

AC5



Informé sur le niveau d'émission de substances volatiles dans l'air intérieur, prévoyant un risque de toxicité par inhalation, sur une échelle de classe allant de A+ (très faibles émissions) à C (fortes émissions)

UNICLIC 

CE

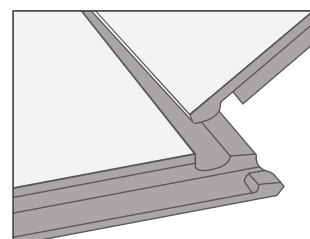
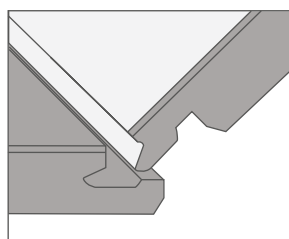



Solid  CLICK XL

VANILLA OAK

De aparência clean e elegante, o padrão VANILLA OAK com o seu tom de bege imaculado, não é uma mera tendência mas sim uma preferência intemporal.

Os seus suaves “nós” conferem-lhe um aspeto extremamente sofisticado e gracioso, tornando-se irrepreensível em qualquer tipo de decoração.

(EN) *With a clean and elegant appearance, the immaculate beige tone of VANILLA OAK is not a mere trend but a timeless preference. Its soft grains give an extremely sophisticated and graceful look making it impeccable in any type of decoration.*

(FR) *Avec un aspect épuré et élégant, le VANILLA OAK avec son ton beige immaculé, n'est pas une simple tendance mais une préférence intemporelle. Ses veines douces lui donnent un aspect extrêmement sophistiqué et gracieux, ce qui lui rend impeccable dans tout type de décoration.*

Ref: 40.0518.001.008

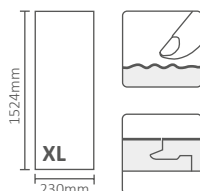

Perfis | Profiles | Profils
Vanilla Oak



Rodapés | Skirtings | Plinthes
Vanilla Oak



Poró "Real Wood"
"Real Wood" Texture
Texture "Real Wood"



Sem Bisel
No Bevel
Pas de Biseau



Solid  CLICK XL

PEARL OAK

O padrão PEARL OAK apresenta uma subtil diferença de tonalidades que o torna num visual único, capaz de elevar a dinâmica estética de qualquer espaço interior. Inspirado nas referências escandinavas e contemporâneas, garante uma conjugação perfeita com madeiras ou lacados.

(EN) The PEARL OAK presents a subtle difference in shades lending a unique look, capable of elevating the aesthetic dynamics of any interior space. Inspired by Scandinavian and contemporary references, it guarantees a perfect combination with wood or lacquered decors.

(FR) Le PEARL OAK présente une subtile différence de teintes que lui donne un look unique, capable d'élever la dynamique esthétique de tout espace intérieur. Inspiré des références scandinaves et contemporaines, il garante une combinaison parfaite avec du bois ou laqué.

Ref: 40.0518.001.007

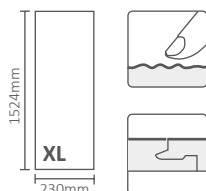

Perfis | Profiles | Profils
Pearl Oak



Rodapés | Skirtings | Plinthes
Pearl Oak



Poro "Real Wood"
"Real Wood" Texture
Texture "Real Wood"



Sem Bisel
No Bevel
Pas de Biseau



Solid  CLICK XL

IRON OAK

O pavimento IRON OAK segue a tendência dos cinzentos futuristas, ostentando alguns “veios” que lhe atribuem uma enorme versatilidade na sua aplicação. O resultado final é sublime quando conjugado com tons claros e uma decoração minimalista. Confere personalidade e conforto a qualquer envolvente.

(EN) *The IRON OAK flooring follows the futuristic grey trend, displaying some grains that brings enormous versatility to its use in any design. The upshot is sublime when combined with light tones and minimalist décor, lending personality and comfort to any surrounding.*

(FR) *Le revêtements de sol IRON OAK suit la tendance du gris futuriste, avec quelques veines qui lui confèrent une énorme polyvalence dans son application. Le résultat final est sublime une fois combiné avec des tons clairs et un décor minimaliste. Il donne de la personnalité et du confort à tous les environnements.*

Ref: 40.0518.001.005

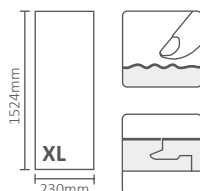

Perfis | Profiles | Profils
Iron Oak



Rodapés | Skirtings | Plinthes
Iron Oak



Poro “Real Wood”
“Real Wood” Texture
Texture “Real Wood”



Sem Bisel
No Bevel
Pas de Biseau



Solid  CLICK XL

NATURE OAK

Evidencia-se dos demais pelo seu padrão com suaves “decapés”, o que lhe atribui um aspeto aprimorado e elegante. O seu tom de mel confundido no realismo do seu semblante permite que se adeque plenamente a decorações modernas e românticas. Oferece a qualquer espaço uma graciosidade e um carisma únicos!

(EN) *It stands out from the rest of the collection for its pattern with smooth pickling wood tone that brings an enhanced and elegant look. Its honey tone allows it to fully adapt to modern and romantic decorations, lending to any space a unique elegance and charisma!*

(FR) *Il se démarque des autres par son motif aux décapés lisses, ce qui lui confère une apparence épuré et élégante. Son ton miel lui permet de s'adapter pleinement aux décors modernes et romantiques. Il offre à chaque espace une grâce et un charisme uniques!*

Ref: 40.0518.001.004

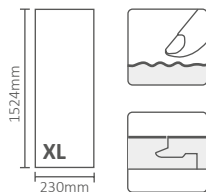

Perfis | Profiles | Profils
Nature Oak



Rodapés | Skirtings | Plinthes
Nature Oak



Poro “Real Wood”
“Real Wood” Texture
Texture “Real Wood”



Sem Bisel
No Bevel
Pas de Biseau



Solid  CLICK XL

HONEY OAK

A inspiração no carvalho natural faz do HONEY OAK um dos padrões mais apreciados da coleção. A versatilidade na sua aplicação é manifesta, exibindo todo o seu potencial nos estilos contemporâneo, retro e até mesmo vintage. O seu look intemporal aliado ao realismo das suas “catedrais” evoca a natureza e a vivacidade em ambientes assumidamente vanguardistas!

(EN) *The inspiration in natural oak makes HONEY OAK one of the most appreciated colours of the entire collection. Its versatility is evident, showing its full potential on contemporary, retro and even on vintage styles. Its timeless look combined with the realism of its “cathedrals”, evokes nature and liveliness in avant-garde environments!*

(FR) *Inspiré par le chêne naturel, HONEY OAK est l'un des motifs les plus appréciés de toute la collection. La polyvalence de son application est évidente, en montrant son plein potentiel dans les styles contemporains, rétro et vintage. Son look intemporel combiné au réalisme de ses “grains”, évoque la nature et la vivacité dans des environnements avant-gardistes!*

Ref: 40.0518.001.001

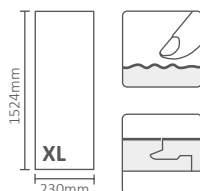

Perfis | Profiles | Profils
Honey Oak



Rodapés | Skirtings | Plinthes
Honey Oak



Poro “Real Wood”
“Real Wood” Texture
Texture “Real Wood”



Sem Bisel
No Bevel
Pas de Biseau



Solid  CLICK XL

ARIZONA OAK

O estilo country está bem patente no pavimento ARIZONA OAK! O seu visual faz mais sentido quando se torna cúmplice das tendências vintage, boémias e ancestrais.

De uma tonalidade ímpar, o ARIZONA OAK é facilmente aceite pelo cliente que procura a diferença e uma habitação mais atrativa e vibrante.

(EN) *The country style is evident in the ARIZONA OAK! Its look makes more sense when blended with vintage, bohemian and ancestral trends. With a unique tone, ARIZONA OAK is easily selected by customers that are looking for the difference and a more attractive home.*

(FR) *Le style "country" est très évident dans le ARIZONA OAK! Son look prend tout son sens quand devient complice de tendances vintage, bohèmes et ancestrales. Avec un ton unique, le ARIZONA OAK est facilement accepté par des clients à la recherche d'une différence et d'une maison plus attrayante.*

Ref: 40.0518.001.003

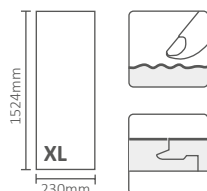

Perfis | Profiles | Profils
Arizona Oak



Rodapés | Skirtings | Plinthes
Arizona Oak



Poro "Real Wood"
"Real Wood" Texture
Texture "Real Wood"



Sem Bisel
No Bevel
Pas de Biseau



Solid  CLICK XL

SMOKED OAK

A multiplicidade de tons fortes elevam o padrão SMOKED OAK para um limiar de absoluto carisma e vigor, tornando-se no elemento chave numa decoração minimalista. O seu visual marcante adorna qualquer tipo de ambiente de extremo primor!

(EN) *The multiplicity of tones of SMOKED OAK lends absolute charisma and vigor, becoming the key element in a minimalist decor. Its striking look upgrades any type of environment to extreme exquisite!*

(FR) *La multiplicité des tons forts élève le SMOKED OAK à un seuil de charisme et de vigueur absolus, en devenant l'élément clé d'un décor minimaliste. Son look saisissant orne tout type d'environnement d'extrême exquis!*

Ref: 40.0518.001.002

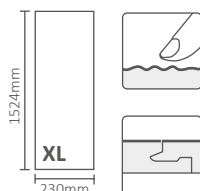

Perfis | Profiles | Profils
Smoked Oak



Rodapés | Skirtings | Plinthes
Smoked Oak



Poro "Real Wood"
"Real Wood" Texture
Texture "Real Wood"



Sem Bisel
No Bevel
Pas de Biseau



Solid  CLICK XL

GRAPHITE OAK

Robustez, intensidade e “hard look” são as palavras de ordem do GRAPHITE OAK. Permite conjugações criativas e vibrantes nos mais diversos estilos decorativos, desde moderno, industrial ou até mesmo rústico.

Um autêntico desafio à sua imaginação!

(EN) *Robustness, intensity and the “hard look” are the watchwords of GRAPHITE OAK. It allows creative and vibrant combinations on the most diverse decorative styles, from modern, industrial or even rustic. A real challenge to your imagination!*

(FR) *Robustesse, intensité et “hard look” sont les maîtres mots du GRAPHITE OAK. Il permet des combinaisons créatives et vibrantes dans les styles décoratifs les plus divers, du moderne, industriel ou même rustique. Un vrai défi pour votre imagination!*

Ref: 40.0518.001.006

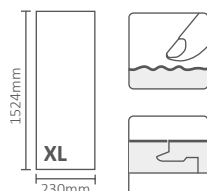

Perfis | Profiles | Profils
Graphite Oak



Rodapés | Skirtings | Plinthes
Graphite Oak



Poro “Real Wood”
“Real Wood” Texture
Texture “Real Wood”



Sem Bisel
No Bevel
Pas de Biseau



Solid  CLICK XL

HARVEST OAK

O destaque do pavimento HARVEST OAK é evidenciado pela sua forte inspiração na madeira natural, com um manifesto realismo e uma extraordinária autenticidade ao toque! O seu tom intemporal confere-lhe elevados índices de versatilidade e compatibilidade, tornando-se sempre numa aposta ganha. O HARVEST OAK é a certeza de uma excepcional sensação de conforto e personalidade em qualquer ambiente!

(EN) *The accent of HARVEST OAK realistic is granted by its strong inspiration on natural wood, offering a realistic and an extraordinary authentic touch! The versatility and harmony of its timeless tone makes it always a winning bet. HARVEST OAK grants an exceptional feeling of comfort and personality to any environment!*

(FR) *Le point fort du parquet HARVEST OAK est mis en évidence par sa forte inspiration dans le bois naturel, d'un réalisme clair et d'une authenticité extraordinaire au toucher ! Son ton intemporel, lui donne des niveaux élevés de polyvalence et compatibilité, en le rendant toujours un pari gagnant. Le HARVEST OAK confère une sensation exceptionnelle de confort et de personnalité à tous les environnements !*

Ref: 40.0518.001.009

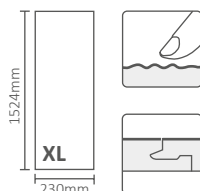

Perfis | Profiles | Profils
Harvest Oak



Rodapés | Skirtings | Plinthes
Harvest Oak



Poro "Real Wood"
"Real Wood" Texture
Texture "Real Wood"



Sem Bisel
No Bevel
Pas de Biseau



Solid  CLICK XL

ARABIAN OAK

O novo ARABIAN OAK apresenta toda uma mística e intensidade que se manifestam na sua dinâmica estética e particularmente no seu toque e na beleza contrastante dos seus veios e tonalidades. Facilmente remete para ambientes elegantes e plenos de dinamismo e originalidade em conciliação com os tipos de decoração moderna, oriental, étnica ou até mesmo vintage. Concede uma personalidade e carisma únicos em qualquer espaço!

(EN) *The new ARABIAN OAK presents a whole mystique and intensity manifested in its aesthetic dynamics and particularly on its touch and on the contrasting beauty of its veins and tones. It easily refers to elegant environments full of dynamism and originality in harmony with modern, oriental, ethnic or even vintage decor types, granting a unique personality and charisma to any space!*

(FR) *Le nouveau ARABIAN OAK présente toute une mystique et une intensité qui se manifestent dans sa dynamique esthétique et particulièrement dans son toucher et la beauté contrastée de ses veines et de ses tons. Il se réfère facilement à des ambiances élégantes pleines de dynamisme et d'originalité en conciliation avec les types de décors modernes, orientaux, ethniques ou encore vintage. Il accorde de la personnalité et du charme uniques à n'importe quel espace!*

Ref: 40.0518.001.014

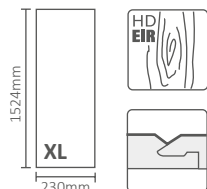

Perfis | Profiles | Profils
Nature Oak



Rodapés | Skirtings | Plinthes
Nature Oak



Solid  CLICK XL

CASTLE OAK

O novo CASTLE OAK celebra a autenticidade do carvalho natural num padrão repleto de carisma. Confere a qualquer espaço um visual aprimorado e moderno, elevando e prestigiando todos os elementos decorativos à sua volta. As suas harmoniosas catedrais fundem-se perfeitamente no seu elegante tom de bege, proporcionando-lhe uma enorme versatilidade nos mais variados tipos de decoração, desde contemporânea, chic casual ou escandinava. Sem dúvida, uma escolha vencedora!

(EN) *The new CASTLE OAK celebrates the authenticity of natural oak in a pattern full of charisma. It gives any space an improved and modern look, elevating all the surrounding decorative elements. Its harmonious "cathedrals" blend perfectly into its elegant beige tone, providing a enormous versatility in the most varied types of decoration, from contemporary, casual chic or scandinavian. Definitely, a winning choice!*

(FR) *Le nouveau CASTLE OAK célèbre l'authenticité du chêne naturel dans un motif plein de charme. Il donne à n'importe quel espace un visuel moderne et amélioré, en élevant tous les éléments décoratifs qui l'entourent. Ses "cathédrales" harmonieuses se fondent parfaitement dans son élégant ton beige or lui conférant une énorme polyvalence dans les différents types de décoration, du contemporain au casual chic en passant par le scandinave. Sans aucun doute, un choix gagnant !*

Ref: 40.0518.001.012

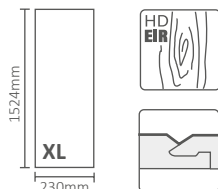

Perfis | Profiles | Profils
Pearl Oak



Rodapés | Skirtings | Plinthes
Pearl Oak



EIR
Poro sincronizado
Embossed in Register



Bisel 4V
Bevel
Biseau



Solid  CLICK XL

IVORY OAK

Com um estilo vanguardista e um toque sofisticado, o novo padrão IVORY OAK segue as tendências atuais e a sua adaptabilidade a qualquer projeto decorativo é simplesmente admirável. O tom intemporal de cinza claro aliado aos seus distintos veios e catedrais tornam-no num pavimento único e muito apreciado, originando um resultado final verdadeiramente vibrante e acolhedor.

(EN) With an avant-garde style and a sophisticated touch, the new IVORY OAK follows the current trends and its adaptability to any decorative project is simply admirable. The timeless tone of light grey combined with its distinct grains and "cathedrals" turns it into a unique and much appreciated flooring, resulting in a truly vibrant and welcoming outcome.

(FR) Avec un style avant-gardiste et une touche sophistiquée, le nouveau motif IVORY OAK suit les tendances actuelles et son adaptabilité à tout projet décoratif est tout simplement admirable. Le ton intemporel du gris clair combiné avec à ses veines et "cathédrales" distinctes lui convert dans un sol unique et très apprécié, en aboutissant à un résultat final vraiment vibrant et accueillant.

Ref: 40.0518.001.013

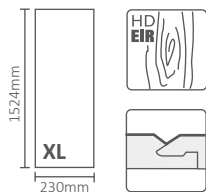

Perfis | Profiles | Profils
Ivory Oak



Rodapés | Skirtings | Plinthes
Ivory Oak



EIR
Poro sincronizado
Embossed in Register



Bisel 4V
Bevel
Biseau



Solid  CLICK XL

RIGA AMBER

A nobreza da riga é expressamente evidente no décor aprimorado da nova Riga Amber! O seu toque e aparência dão um efeito de madeira muito natural, oferecendo uma riqueza e qualidade decorativa incontestáveis. Uma solução de excelência e versatilidade que se funde em pleno nos estilos decorativos clássicos ou vanguardistas, particularmente com inspirações Boho, orientais e provençais!

(EN) *Riga's nobility is expressly evident on the enhanced decor of the new Riga Amber! Its touch and appearance delivers a very natural wood effect, offering an undeniable richness and decorative quality. A solution of excellence and versatility that fully merges with classic or avant-garde decorative styles, particularly with Boho, Oriental or Provence inspirations!*

(FR) *La noblesse de Riga s'exprime dans le décor amélioré du nouveau Riga Amber ! Son toucher et son aspect lui confèrent un effet bois très naturel, offrant en une richesse et une qualité décorative indéniables. Une solution d'excellence et de versatilité qui se fond parfaitement avec les styles décoratifs classiques ou avant-gardistes, notamment avec les inspirations bohèmes, orientales et provençales!*

Ref: 40.0518.001.010

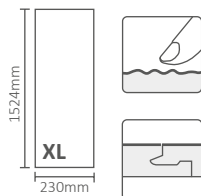

Perfis | Profiles | Profils
Riga Amber



Rodapés | Skirtings | Plinthes
Riga Amber



Poró "Real Wood"
"Real Wood" Texture
Texture "Real Wood"



Sem Bisel
No Bevel
Pas de Biseau



Solid  CLICK XL

RIGA TERRACOTA



A nova Riga Terracota manifesta todo um visual exótico e carismático e torna-se no elemento mais excêntrico em qualquer ambiente decorativo! Combina plenamente com o branco imaculado, incorporado nos estilos minimalista, clean e escandinavo! O seu design apresenta variações de profundidade onde os distintos veios e “catedrais” acentuam os detalhes genuínos da riga. Concede charme e exuberância a qualquer espaço!

(EN) *The new RIGA TERRACOTA shows an exotic and charismatic look and becomes the most eccentric element on any home decor! It perfectly matches with the immaculate white, incorporated in minimalistic, clean and Scandinavian styles! Its design presents depth variations where the distinct grains and “cathedrals” accentuate the Riga’s genuine details. It grants charm and exuberance to any space!*

(FR) *Le nouveau RIGA TERRACOTA affiche un look exotique et charismatic et devient l’élément le plus excentrique de tout environnement décoratif ! Il s’accorde parfaitement avec le blanc immaculé, incorporé dans des styles minimalistes, épurés et scandinaves ! Sa conception présente des variations de profondeur où les distinctes veines et “cathédrales” accentuent les détails authentiques de Riga, en accordant du charme et de l’exubérance à n’importe quel espace!*

Ref: 40.0518.001.011

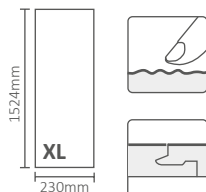

Perfis | Profiles | Profils
Riga Terracota



Rodapés | Skirtings | Plinthes
Riga Terracota



Poro “Real Wood”
“Real Wood” Texture
Texture “Real Wood”



Sem Bisel
No Bevel
Pas de Biseau

SOLID CLICK XL - FICHA TÉCNICA

TECHNICAL SHEET | FICHE TÉCNIQUE

DIMENSÃO DIMENSION (mm)	ESPESSURA THICKNESS ÉPAISSEUR (mm)	PCS/CAIXA PCS/BOX PCS/BOÎTE	M ² /CAIXA M ² /BOX M ² /BOÎTE	KGS/CAIXA KGS/BOX KGS/BOÎTE	CAMADA DE DESGASTE WEAR LAYER COUCHE D'USURE (mm)	CAIXA/PALETE BOXES/PALLET BOÎTES/PALETTE	M ² /PALETE M ² /PALLET M ² /PALETTE
1524 x 230	6,5*	5	1,7526	18,5	0,7	64	112,16

* Espessura 6,5 mm, com tela de isolamento IXPE 1,5 mm incorporada.
With 1,5 mm IXPE built-in underlay.
Avec sous-couche IXPE de 1,5 mm intégrée.

TESTE DE DESEMPENHO ITEM TEST / TESTS DE PERFOR	NORMAS STANDARDS NORMES	RESULTADOS RESULTS RÉSULTATS
Camada de desgaste Wear layer / Couche d'usure		0,7 mm
Nível de Uso Usage Level Niveau d'utilisation	EN 685	23/33/42
Estabilidade Dimensional Dimensional stability Stabilité dimensionnelle	ISO 23999:2018	Dir. X = 0.00% Dir. Y = 0,05
Ondulação Curling Gondolage	ISO 23999:2018	0.00%
Classe de Abrasão Abrasion Class Classe d'abrasion	EN 660-2	Classe / Class P
Resistência à abrasão Abrasion resistance Résistance à l'abrasion	EN 13329:2016 Annex E	AC5
Resistência ao fogo Fire resistance Résistance au feu	EN 13501-1	Bfl-s1
Qualidade do ar interior Indoor air quality Qualité de l'air intérieur	ISO 16000	A+
COV (Composto orgânico Volátil) VOC (Volatile Organic Compounds)	FloorScore	Aprovado Approved Approuvé
Metais pesados Soluble heavy metal Métaux lourds	ASTM F963-11	Aprovado Approved Approuvé
Isolamento ao ruído de impacto Impact Noise reduction Isolation contre le bruit d'impact	ISO 10140-3:2010	21dB
Indentação Residual Residual Indentation Indentation résiduelle	ASTM F1914-07 ASTM F1700-13a	0,1%
Resistência à carga estática Static load resistance Résistance à la charge statique	ASTM F970-15	0 mm
Emissão de formaldeído Formaldehyde Emission Emission de formaldéhyde	EN 717-1	E0
Tipo de Clique Click Type Type de clic		Uniclic 4 lados 4 sides 4 côtés
Absorção após submersão em água Absorption after submersion in water Absorption après immersion dans l'eau	EN 16511	0%
Resistência à exposição ao calor a 80°C/180°F Heat exposure resistance 80°C/180°F Résistance à l'exposition à la chaleur à 80°C/180°F	ASTM 1700	Aprovado Approved Approuvé
TOLERÂNCIAS: TOLERANCES: TOLÉRANCES:	Espessura Thickness Épaisseur	+/-0,2mm
	Largura Width Largeur	+/-0,1mm
	Comprimento Length Longueur	+/-0,5mm
NÚCLEO: CORE: NOYAU:	Tipo de Núcleo Core Type Type de noyau	60% Pó de pedra + 20% PVC + 20% outros 60% Stone dust + 20% PVC + 20% others 60% Poudre de pierre + 20% PVC + 20% d'autres
	Espessura Thickness Épaisseur	4,3 mm
	Densidade Density Densité	≥ 2000Kg/m ³
TELA DE ISOLAMENTO ISOLATION SCREEN SOUS COUCHES	Tipo Type	IXPE
	Densidade Density Densité	132 Kg/m ³
	Espessura Thickness Épaisseur	1,5 mm

DOMÉSTICO
DOMESTIC



COMERCIAL
COMMERCIAL



Consulte as condições gerais de garantia em gsfloors.pt.
A cor e padrão dos pavimentos podem variar para o produto original.

(EN) Please check the general guarantee conditions on gsfloors.pt.
The colors and patterns of flooring can vary from the original product.

(FR) Consultez les conditions générales de garantie à gsfloors.pt.
La couleur et le motif de revêtements du parquet peut varier du produit original.



GSfloors®
flooring solutions by gosimat

COMPLEMENTOS

COMPLEMENTS | COMPLÉMENTS

RODAPÉS

SKIRTINGS | PLINTHES

PERFIS DE REMATE

PROFILES | PROFILS

TELAS DE ISOLAMENTO

ISOLATION UNDERLAY | SOUS COUCHES

RODAPÉ WPC

WPC SKIRTING BOARD | PLINTHE EN WPC

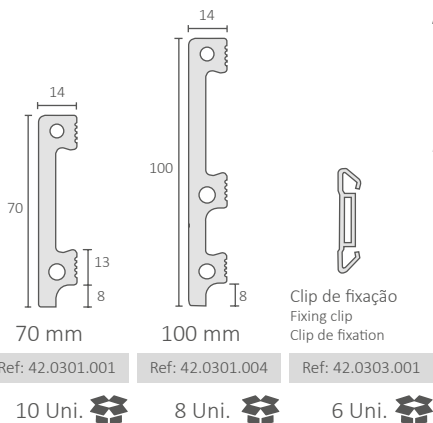

Comprimento Length Longueur:	2300 2500 mm
Altura Height Hauteur:	70 100 mm
Espessura Thickness Épaisseur:	14 mm
Densidade Density Densité:	800 Kgs/m ³
Material de base Made of Fabriqué en:	Compósito de madeira e plástico (WPC) Wood and plastic composite (WPC) Composite de bois et plastique (WPC)
Revestimentos disponíveis: Available Coatings: Revêtements disponibles:	Folha PVC PVC Foil Feuille de PVC: (180µ) Folha Decor Decor Foil Feuille Decor: (180 µ) Folha Vinil Vinyl Vinyle: (120 - 150 µ)



Rodapé fabricado em compósito de madeira e plástico (PVC), de elevada resistência à humidade e de fácil manutenção. Indicado para aplicação em pavimentos cerâmicos, vinílicos e flutuantes. Devido à flexibilidade do WPC, este rodapé pode ser instalado em superfícies curvas.

(EN) - Skirting manufactured in wood and plastic composite (PVC) with highly moisture-resistant and easy to maintain. The WPC skirting is indicated for ceramic, vinyl and floating floorings. Due to the WPC flexibility, this skirting can be installed on curved surfaces.

(FR) - Plinthe fabriquée en composite de bois et plastique (PVC), très résistante à l'humidité et facile à entretenir. Indiqué pour l'application dans des planchers en céramique, en vinyle et flottants. Grâce à la flexibilité du WPC, cette plinthe peut être installée sur des surfaces courbes.

TIPOS DE APLICAÇÃO POSSÍVEIS | POSSIBLE TYPES OF APPLICATION | TYPES D'APPLICATION POSSIBLES



1 Fixação com clip de fixação*
Clamping clip
Clip de fixation



2 Cola Prego | Cola e veda
Adhesive and sealant
Colle-mastic



3 Espuma adesiva rápida PU (baixa expansão)
PU adhesive foam - low expansive
Mousse adhésive PU - faible expansion

* (Distância recomendada entre cliques: cerca de 500 mm) | (Recommended distance between clips: about 500 mm) | (Distance recommandée entre les cliques : environ 500 mm)

RODAPÉ MADEIRA

WOOD SKIRTING BOARD | PLINTHE EN BOIS

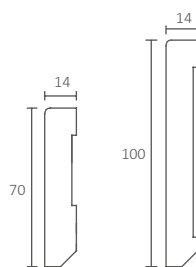
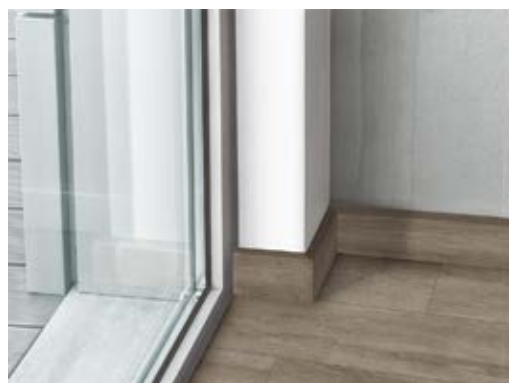

70 mm Ref: 42.0201.001	10 Uni.
100 mm** Ref: 42.0201.002	8 Uni.

Comprimento | Length | Longueur:
2300 | 2500 mm

Revestimentos disponíveis:
Available Coatings:
Revêtements disponibles:

Folha PVC | PVC Foil | Feuille de PVC: (180 µ)
Folha Decor | Decor Foil | Feuille Decor: (180 µ)
Folha Vinil | Vinyl | Vinyle: (120 - 150 µ)



Com um design clean e padrões que possibilitam a consonância estética perfeita com quase todo o tipo de pavimentos, a gama de rodapés com base em pinho americano, revestidos a PVC é fabricada com matérias primas de grande qualidade e requer pouca manutenção.

(EN) - With smooth lines and patterns that allows the perfect aesthetic harmony with almost all types of floorings, the skirting boards range in pine core, coated in PVC is produced with high quality materials and require low maintenance.

(FR) - Avec des lignes simples et des motifs qui permettent une harmonie esthétique parfaite, la gamme de plinthes à base de pin, revêtu de PVC, est fabriqué avec des matières d'haute qualité et avec faibles exigences de maintenance.

** Rodapé de madeira de 100 mm de altura encontra-se em período de descontinuação. Limitado ao stock existente.
100 mm height wooden skirting board is in a discontinuation period. Limited to existing stock. | Plinthe en bois de 100 mm de hauteur est en période de discontinuation. Limité au stock existant.

RODAPÉ DE ALUMÍNIO

ALUMINIUM SKIRTING BOARD | PLINTHE EN ALUMINIUM

Clip de rodapé de alumínio
Skirting board clip | Plinthe clip

50 x 12 mm 70 x 14 mm 100 x 14 mm

Ref: 42.0101.001 Ref: 42.0101.002 Ref: 42.0101.003

6 Uni. 6 Uni. 6 Uni. **Comprimento | Length | Longueur:** 2500 mm

(Distância recomendada entre cliques: cerca de 500 mm)
(Recommended distance between clips: about 500 mm)
(Distance recommandée entre les clips : environ 500 mm)

AN 6 Uni.

O rodapé de alumínio **GS FLOORS** é elegante, minimalista e de enorme qualidade. Aplicado em conjunto com o clip de fixação, confere bastante segurança na sua utilização e aderência à parede. Permite armazenar fios e cabos de serviço, ocultando-os da vista, proporcionando uma maior harmonia estética.

(EN) - The **GS FLOORS** aluminum skirting board is elegant, minimalist and of high quality. Applied together with the fixing clip, it provides high security in its use and adherence to the wall. It allows to hide service wires and cables, providing greater aesthetic harmony.

(FR) - La plinthe en aluminium **GS FLOORS** est élégante, minimaliste et de grande qualité. Appliquée avec le clip de fixation, elle offre beaucoup de sécurité dans son utilisation et son adhérence au mur. Elle permet de ranger les fils et câbles de service, en les cachant de la vue, en offrant une plus grande harmonie esthétique.

CANTOS PARA RODAPÉ DE ALUMÍNIO

CORNERS FOR ALUMINIUM SKIRTING | COINS POUR PLINTHE EN ALUMINIUM

<p>Canto exterior Outside corner Coin extérieur</p>	Ref: 42.0102.017 50 x 12 mm	<p>Canto interior Inside corner Coin intérieur</p>	Ref: 42.0102.015 50 x 12 mm	<p>Topo (esquerdo / direito) Top (left / right) Embout (gauche / droite)</p>	Ref: 42.0102.022 50 x 12 mm
	Ref: 42.0102.020 70 x 14 mm		Ref: 42.0102.016 70 x 14 mm		Ref: 42.0102.023 70 x 14 mm
	Ref: 42.0102.021 100 x 14 mm		Ref: 42.0102.018 100 x 14 mm		Ref: 42.0102.024 100 x 14 mm

ABS 1 Uni. ABS 1 Uni. ABS 1 Uni.

RODAPÉ DE EMBUTIR

WALL FLUSH SKIRTING | PLINTHE INVISIBLE

RODAPÉ DE EMBUTIR COM ABA
WALL FLUSH SKIRTING WITH JOINT COVER | PLINTHE INVISIBLE AVEC AILE COUVRE JOINT

Ref: 42.0101.004

Embutido simples com ou sem led.
- Simple wall flush skirting with or without led.
- Simple plinthe invisible avec or sans led.

Comprimento | Length | Longueur: 2500 mm

AN 1 Uni.

Fita led (não incluída).
Led strip (not included).
Bande led (non inclus).

RODAPÉ DE EMBUTIR
WALL FLUSH SKIRTING | PLINTHE INVISIBLE

Ref: 42.0101.008

***Rodapé WPC (não incluído)**
WPC skirting board (not included)
Plinthe en WPC (non inclus)

Comprimento | Length | Longueur: 2500 mm

AN 1 Uni.

(Rodapé WPC Opcional)
(WPC skirting optional)
(Plinthe WPC Optionnel)

SÉRIE ALUMÍNIO LVT | SPC | LVT | SPC Aluminium Serie | Serie Aluminium LVT | SPC

PERFIL DE TRANSIÇÃO

Transition profile | Profil de transition

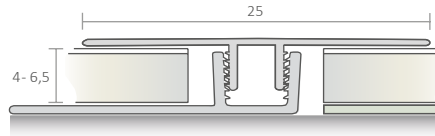

Ref: 43.0102.004

25mm



Comprimento | Length | Longueur: 2500 mm

AN LVT SPC

10 Uni.

PERFIL TERMINAL

Edge profile | Profil d'arrêt

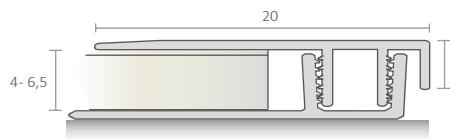

Ref: 43.0201.002

20mm



Comprimento | Length | Longueur: 2500 mm

AN LVT SPC

10 Uni.

PERFIL DESNÍVEL

Adaptation profile | Profil d'adaptation

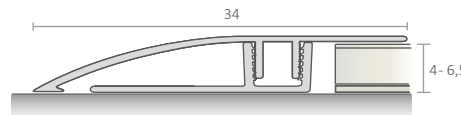

Ref: 43.0302.004

34mm



Comprimento | Length | Longueur: 2500 mm

AN LVT SPC

10 Uni.

BASE ALUMÍNIO

Aluminium base | Base en aluminium

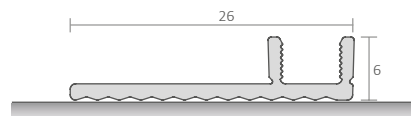

Ref: 43.0602.003

Para pavimentos de 4 a 6 mm

For floorings from 4 to 6 mm

Pour des sols de 4 à 6 mm

AB

10 Uni.

Comprimento | Length | Longueur: 2500 mm

Os perfis de remate em alumínio foram desenvolvidos para possibilitar uma transição perfeita entre as juntas no pavimento. Proporcionam um encaixe perfeito e um resultado final esteticamente atrativo. Acabamento em alumínio ou revestimento com lâminas decorativas nas cores e padrões das gamas de pavimento **SOLID CLICK XL** e **PRIME CLICK**.

(EN) - The aluminum finishing profiles have been developed to enable a seamless transition between the joints of the flooring. They provide a perfect fit and a very attractive aesthetic result. In anodized aluminum finish or coated in the same decors and patterns of the **SOLID CLICK XL** and **PRIME CLICK** flooring ranges.

(FR) - Les profils de finition de l'aluminium ont été développés pour permettre une transition parfaite entre les joints du parquet. L'ajustement parfait permet un résultat final esthétiquement attrayant. Finition en aluminium ou en revêtement avec des couleurs et des motifs de **SOLID CLICK XL** et **PRIME CLICK** gammes de revêtements de sol.

SÉRIE ALUMÍNIO COM BASE PVC | PVC Base - Aluminium Serie | Serie Aluminium avec base en PVC

PERFIL DE TRANSIÇÃO

Transition profile | Profil de transition

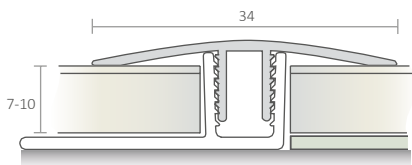

Ref: 43.0102.001

34mm

Para pavimentos até 10 mm
For floorings until 10 mm
Pour des sols jusqu'à 10 mm

AN PVC

10 Uni.

Comprimento | Length | Longueur: 2500 mm

PERFIL DE TRANSIÇÃO

Transition profile | Profil de transition

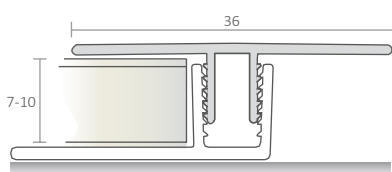

Ref: 43.0102.002

36mm

Para pavimentos até 10 mm
For floorings until 10 mm
Pour des sols jusqu'à 10 mm

AN PVC LVT SPC

10 Uni.

Comprimento | Length | Longueur: 2500 mm

PERFIL DESNÍVEL

Adaptation profile | Profil d'adaptation

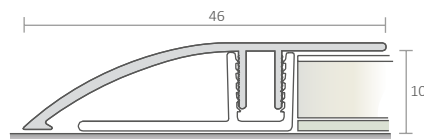

Ref: 43.0302.001

46mm

Para pavimentos até 10 mm
For floorings until 10 mm
Pour des sols jusqu'à 10 mm

AN PVC LVT SPC

10 Uni.

Comprimento | Length | Longueur: 2500 mm

PERFIL DESNÍVEL

Adaptation profile | Profil d'adaptation

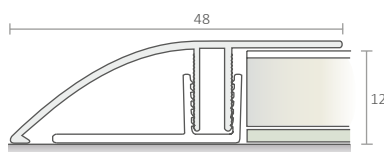

Ref: 43.0302.002

48mm

Para pavimentos até 12 mm
For floorings until 12 mm
Pour des sols jusqu'à 12 mm

AN PVC

10 Uni.

Comprimento | Length | Longueur: 2500 mm

PERFIL DESNÍVEL

Adaptation profile | Profil d'adaptation

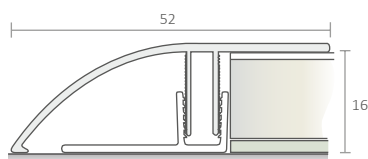

Ref: 43.0302.003

52mm

Para pavimentos até 16 mm
For floorings until 16 mm
Pour des sols jusqu'à 16 mm

AN PVC

10 Uni.

Comprimento | Length | Longueur: 2500 mm

PERFIL TERMINAL

Edge profile | Profil d'arrêt

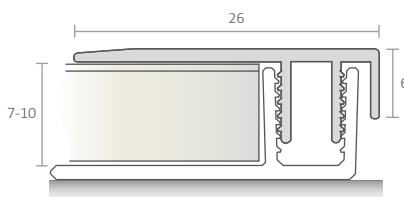

Ref: 43.0201.001

26 mm

Para pavimentos até 10 mm
For floorings until 10mm
Pour des sols jusqu'à 10 mm

AN PVC LVT SPC 10 Uni.

Comprimento | Length | Longueur: 2500 mm

PERFIL RAMPA

Ramp profile | Profil de rampe

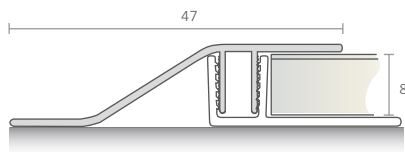

Ref: 43.0402.001

47 mm

Para pavimentos até 8 mm
For floorings until 8 mm
Pour des sols jusqu'à 8 mm

AN PVC 10 Uni.

Comprimento | Length | Longueur: 2500 mm

ESPECIFICAÇÕES | SPECIFICATIONS | SPÉCIFICATIONS

Liga Alumínio EN AW - 6030 / 6060 (AL MG SI) T5/6 EN 573-3 e EN 755-2

Aluminum Alloy: EN AW - 6030 / 6060 (AL MG SI) T5/6 EN 573-3 e EN 755-2

Alliage d'aluminium: EN AW - 6030 / 6060 (AL MG SI) T5/6 EN 573-3 e EN 755-2

Base necessária para a instalação

Base required for installation

Base nécessaire pour la pose

SÉRIE PERFIL E BASE PVC | Profile Serie and PVC Base | Serie Profil et base en PVC

PERFIL DE TRANSIÇÃO

Transition profile | Profil de transition

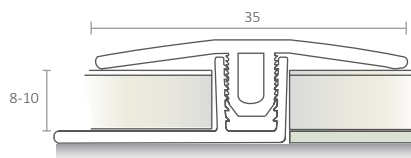

Ref: 43.0102.003

35 mm

Para pavimentos até 10 mm
For floorings until 10 mm
Pour des sols jusqu'à 10 mm

PVC PVC 10 Uni.

Comprimento | Length | Longueur: 2500 mm

BASE PVC

PVC Base | Base en PVC

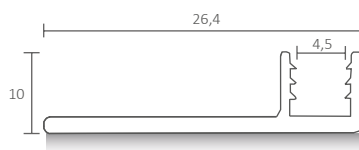

Ref: 43.0601.001

7 - 12 mm

Para pavimentos até 12 mm
For floorings until 12 mm
Pour des sols jusqu'à 12 mm

PVC PVC 10 Uni.

Comprimento | Length | Longueur: 2500 mm

BASE PVC

PVC Base | Base en PVC

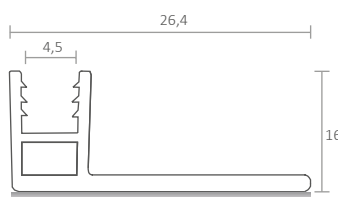

Ref: 43.0601.002

14 - 16 mm

Para pavimentos até 16 mm
For floorings until 16 mm
Pour des sols jusqu'à 16 mm

PVC PVC 10 Uni.

Comprimento | Length | Longueur: 2500 mm

SÉRIE ALUMÍNIO TAPITE | Aluminium Tapite Serie | Serie Aluminium Tapite

PERFIL DE TRANSIÇÃO

Transition profile | Profil de transition

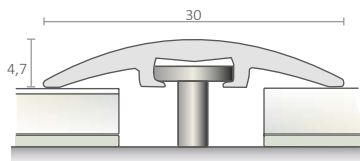

Ref: 43.0101.001

30mm

Fixação por parafuso tapit
Nail anchor fixing
Fixation par Cheville invisible

AN PVC

10 Uni.

Comprimento | Length | Longueur: 2500 mm

PERFIL DE TRANSIÇÃO

Transition profile | Profil de transition

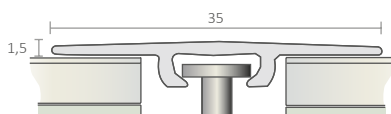

Ref: 43.0101.002

35mm

Fixação por parafuso tapit
Nail anchor fixing
Fixation par Cheville invisible

AN PVC

10 Uni.

Comprimento | Length | Longueur: 2500 mm

PERFIL DE TRANSIÇÃO

Transition profile | Profil de transition

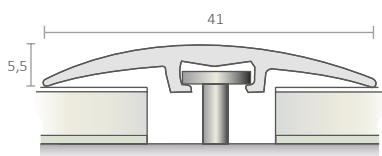

Ref: 43.0101.003

41mm

Fixação por parafuso tapit
Nail anchor fixing
Fixation par Cheville invisible

AN PVC

10 Uni.

Comprimento | Length | Longueur: 2500 mm

INCLUI | INCLUDES | INCLUS:

9 parafusos tapite de 6,45 mm

9 6,45 mm nail anchors | 9 chevilles invisibles de 6,45 mm



ESPECIFICAÇÕES | SPECIFICATIONS | SPÉCIFICATIONS

Liga Alumínio EN AW - 6030 / 6060 (AL MG SI) T5/6 EN 573-3 e EN 755-2

Aluminum Alloy: EN AW - 6030 / 6060 (AL MG SI) T5/6 EN 573-3 e EN 755-2

Alliage d'aluminium: EN AW - 6030 / 6060 (AL MG SI) T5/6 EN 573-3 e EN 755-2

SÉRIE ALUMÍNIO TERMINAL | Aluminium End Profile Serie | Serie Aluminium Finition Profils

PERFIL TERMINAL
Edge profile | Profil d'arrêt

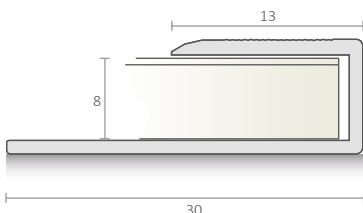

Ref: 43.0202.001

8 - 13 mm

Para pavimentos até 8 mm
For floorings until 8 mm
Pour des sols jusqu'à 8 mm

AN PVC

10 Uni.

Comprimento | Length | Longueur: 2500 mm

PERFIL TERMINAL
Edge profile | Profil d'arrêt

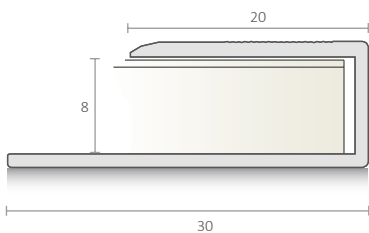

Ref: 43.0202.002

8 - 20 mm

Para pavimentos até 8 mm
For floorings until 8 mm
Pour des sols jusqu'à 8 mm

AN PVC

10 Uni.

Comprimento | Length | Longueur: 2500 mm

PERFIL TERMINAL
Edge profile | Profil d'arrêt

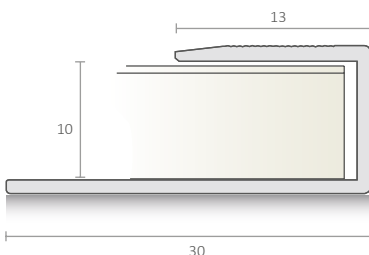

Ref: 43.0202.003

10 - 13 mm

Para pavimentos até 10 mm
For floorings until 10 mm
Pour des sols jusqu'à 10 mm

AN PVC

10 Uni.

Comprimento | Length | Longueur: 2500 mm

PERFIL TERMINAL
Edge profile | Profil d'arrêt

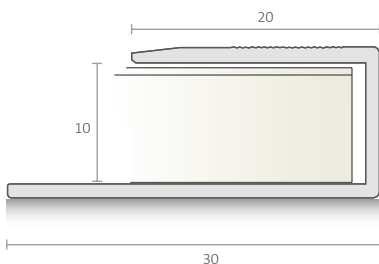

Ref: 43.0202.004

10 - 20 mm

Para pavimentos até 10 mm
For floorings until 10 mm
Pour des sols jusqu'à 10 mm

AN PVC

10 Uni.

Comprimento | Length | Longueur: 2500 mm

PERFIL TERMINAL
Edge profile | Profil d'arrêt

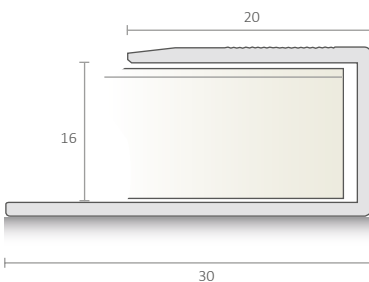

Ref: 43.0202.005

16 - 20 mm

Para pavimentos até 16 mm
For floorings until 16 mm
Pour des sols jusqu'à 16 mm

AN PVC

10 Uni.

Comprimento | Length | Longueur: 2500 mm

SÉRIE ALUMÍNIO BASE ALUMÍNIO | Aluminium serie with aluminium base | Serie Aluminium avec base en aluminium

PERFIL DE ESCADA
Stair profile | Nez de marche

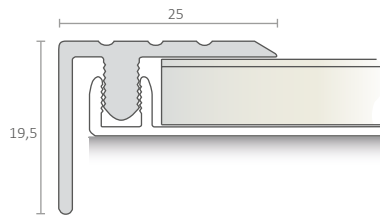

Ref: 43.0502.001

25 mm

Base necessária para a instalação
Base required for installation
Base nécessaire pour la pose

AN PVC

10 Uni.

Comprimento | Length | Longueur: 2500 mm

PERFIL DE TOPO
Edge profile | Profil d'arrêt

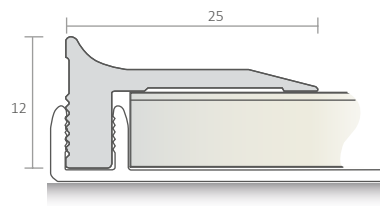
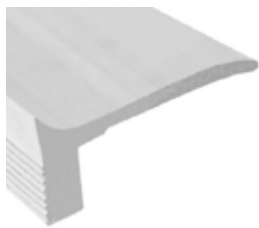

Ref: 43.0502.002

25 mm

Base necessária para a instalação
Base required for installation
Base nécessaire pour la pose

AN PVC

10 Uni.

Comprimento | Length | Longueur: 2500 mm

BASE DE FIXAÇÃO
Fixation base | Base de fixation

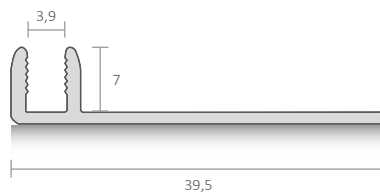

Ref: 43.0602.001

7 - 12 mm

Para pavimentos de 7 a 12 mm
For floorings from 7 to 12 mm
Pour lames de 7 à 12 mm

AB

10 Uni.

Comprimento | Length | Longueur: 2500 mm

BASE DE FIXAÇÃO
Fixation base | Base de fixation

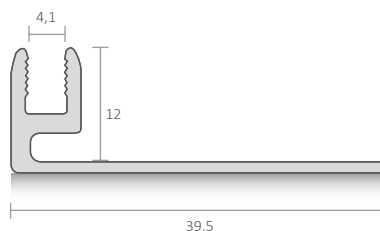

Ref: 43.0602.002

12 - 15 mm

Para pavimentos de 12 a 15 mm
For floorings from 12 to 15 mm
Pour lames de 12 à 15 mm

AB

10 Uni.

Comprimento | Length | Longueur: 2500 mm

Perfil de Escada SPC | SPC Stair Profile | Nez de marche SPC

PERFIL DE ESCADA SPC
SPC Stair profile | Nez de marche SPC

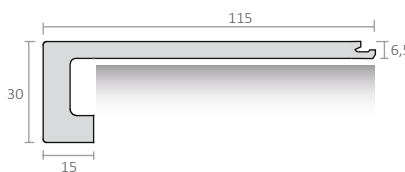

Ref: SPC | DECOR

43.0502.003.001	Honey Oak
43.0502.003.002	Smoked Oak
43.0502.003.003	Arizona Oak
43.0502.003.004	Nature Oak
43.0502.003.005	Iron Oak
43.0502.003.006	Graphite Oak
43.0502.003.007	Pearl Oak
43.0502.003.008	Vanilla Oak
43.0502.003.009	Harvest Oak
43.0502.003.010	Riga Amber
43.0502.003.011	Riga Terracota
43.0502.003.012	Castle Oak
43.0502.003.013	Ivory Oak
43.0502.003.014	Arabian Oak

Para pavimento SPC SOLID CLICK
For SPC SOLID CLICK flooring
Pour lames SPC SOLID CLICK

SPC

2 Uni.

Comprimento | Length | Longueur: 1200 mm

Resistência | Resistance | Résistance :

- Classes | Class | Classe: 23 | 33 | 42

- Camada desgaste

Wear layer | Couche d'usure 0,7 mm

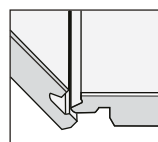

TELAS DE ISOLAMENTO | UNDERLAY | SOUS COUCHES

TIPO DE TELA UNDERLAY TYPE TYPE DE SOUS COUCHES	CARACTERÍSTICAS CHARACTERISTICS CARACTÉRISTIQUES							
	Rolo Roll (m²)	Espessura Thickness Épaisseur (mm)	Largura Width Largeur (m)	 (Kg/m³)	 (m² K/W)	 (%)	 (dB)	
Ref: 44.0202.001 	LVT F LVT F LVT F							
	10	1,5	1	950	0,0091	38,1	18	✓
Ref: 44.0201.008 	EVA FLEX RADIANT Eva Flex Radiant Eva Flex Radiant							
	30	2	1,2	150	0,022	22	22	✓
Ref: 44.0201.007 	EVA FLEX EKO Eva Flex Eko Eva Flex Eko							
	30	2	1	650	0,055	35	30	✓
Ref: 44.0201.005 006 	EVA FLEX Eva Flex Eva Flex							
	15 30	2	1,2	125	0,044	22	26	✓
Ref: 44.0102.006 008 	TOP PARQUET (Polietileno com plástico) Polyethylene with plastic Polyéthylène avec plastique isolant							
	90 45	3	1,2	24	—	—	18	✓
Ref: 44.0102.010 	ECO PARQUET (Polietileno com plástico) Polyethylene with plastic Polyéthylène avec plastique isolant							
	75	2	1,2	20	0,04	—	17 19	✓
Ref: 44.0201.002 	ACÚSTICO FAUS RADIANT Faus Radiant Isolation Acoustique Faus Radiant							
	30	2	1,2	50	0,044	22	26	✓
Ref: 44.0302.001 002 003 	CORTIÇA COM PLÁSTICO Cork with plastic isolation underlay Liège avec plastique isolant							
	10 15 25	2	1	550-650	0,027	—	19	✓



GSfloors[®]

flooring solutions by gosimat

CORES DISPONÍVEIS

AVAILABLE COLOURS | COULEURS DISPONIBLES



CORRESPONDÊNCIA DE PADRÕES

COLOUR CORRESPONDENCE | CORRESPONDANCE DES MOTIFS



FAUS

FINfloor









www.finfloor.com

GAMA Gamma Gamme	RODAPÉS Skirtings Plinthes		PERFIS DE REMATE Aluminium Profiles Profils en aluminium						
	WPC WPC Pag.20	Madeira Wood Bois Pag.20	LVT / SPC LVT / SPC Pag.22	Alumínio c/ base PVC Aluminium w/ PVC base Aluminium av/ base PVC Pag.23	Perfil e base PVC Profile and PVC base Profil et base PVC Pag.24	Tapit Nail anchor Cheville Pag.25	Terminal End Profile Finition Pag.26	Base alumínio Aluminium base Base aluminium Pag.27	
PVC PVC PVC PVC									
	Carvalho Branco <i>White Oak Chêne Blanc</i>	✓	✓	—	✓	✓	✓	✓	✓
	Carvalho Reconst. <i>Rebuilt Oak Chêne Reconst.</i>	✓	✓	—	✓	✓	✓	✓	✓
	Carvalho nº2 <i>Oak nº2 Chêne nº2</i>	—	—	—	✓	✓	✓	✓	✓
	Cerejeira <i>Cherry Cerisier</i>	✓	✓	—	✓	✓	✓	✓	✓
	Faia Vaporizada <i>Streamed beech Hêtre étuvé</i>	—	—	—	✓	✓	✓	✓	✓
	Mogno <i>Mahogany Acajou</i>	✓	✓	—	✓	✓	✓	✓	✓
	Nogueira <i>Walnut Noyer</i>	✓	✓	✓	✓	✓	✓	✓	✓
	Prata II <i>II Silver Argent II</i>	✓	✓	—	—	—	—	—	—
	Sucupira <i>Sucupira</i>	✓	✓	—	✓	✓	✓	✓	✓
	Teka <i>Teak Teck</i>	✓	✓	—	✓	✓	✓	✓	✓
	Wengue <i>Wenge Wenge</i>	✓	✓	—	✓	✓	✓	✓	✓

VIN VINIL Vinyl Vinyle									
	Branco Artico <i>Artic White Blanc Artic</i>	✓	✓	—	—	—	—	—	—
	Branco Pérola <i>Pearl White Blanc Perla</i>	✓	✓	—	—	—	—	—	—
	Moldau Acacia <i>Moldau Acacia</i>	✓	✓	—	—	—	—	—	—
	Carvalho Antiqua <i>Antiqua Oak Chêne Antiqua</i>	✓	✓	—	—	—	—	—	—
	Olmo Escuro <i>Dark Elm Orme Foncé</i>	✓	✓	—	—	—	—	—	—
	Carvalho Plomo <i>Plomb Oak Chêne Plomb</i>	✓	✓	—	—	—	—	—	—
	Carvalho Brown <i>Brown Oak Chêne Brun</i>	✓	✓	—	—	—	—	—	—
	Light Grey <i>Light Grey</i>	✓	✓	—	—	—	—	—	—
	Dark Grey <i>Dark Grey Gris Foncé</i>	✓	✓	—	—	—	—	—	—
	Carvalho Natural <i>Natural Oak Chêne Natural</i>	✓	✓	—	—	—	—	—	—
	Carvalho Savannah <i>Savannah Oak C. Savannah</i>	✓	✓	—	—	—	—	—	—
	Nogueira Cacao <i>Cacao Walnut Noyer Cacao</i>	✓	✓	—	—	—	—	—	—
	Concrete <i>Concrete Béton</i>	✓	✓	—	—	—	—	—	—
	Olmo Taupe <i>Taupe Elm Orme Taupe</i>	✓	✓	—	—	—	—	—	—
	Olmo Gris <i>Grey Elm Orme Gris</i>	✓	✓	—	—	—	—	—	—











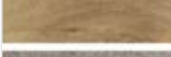

GAMA Gamma Gamme	RODAPÉS Skirtings Plinthes		PERFIS DE REMATE Aluminium Profiles Profils en aluminium						
	WPC WPC Pag.20	Madeira Wood Bois Pag.20	LVT / SPC LVT / SPC Pag.22	Alumínio c/ base PVC Aluminium w/ PVC base Aluminium av/ base PVC Pag.23	Perfil e base PVC Profile and PVC base Profil et base PVC Pag.24	Tapit Nail anchor Cheville Pag.25	Terminal End Profile Finition Pag.26	Base alumínio Aluminium base Base aluminium Pag.27	

LVT DECOR - LVT | LVT Decor | Decor - LVT

* 	Alaska Oak Alaska Oak	—	—	✓	✓	—	—	—	—
* 	Antracite Oak Antracite Oak	—	—	✓	✓	—	—	—	—
* 	Blond Oak Blond Oak	—	—	✓	✓	—	—	—	—
* 	Country Oak Country Oak	—	—	✓	✓	—	—	—	—
* 	Fox Oak Fox Oak	—	—	✓	✓	—	—	—	—
* 	Golden Oak Golden Oak	—	—	✓	✓	—	—	—	—
* 	Nordic Oak Nordic Oak	—	—	✓	✓	—	—	—	—
* 	Sand Oak Sand Oak	—	—	✓	✓	—	—	—	—
* 	Tobacco Oak Tobacco Oak	—	—	✓	✓	—	—	—	—

* Cores a descontinuar. Limitadas ao stock existente | Discontinued colors. Limited to existing stock. | Couleurs à supprimer. Limité au stock existant.

SPC DECOR - SPC | SPC Decor | Decor - SPC

	Arizona Oak Arizona Oak	✓	✓	✓	✓	—	—	—	—
	Graphite Oak Graphite Oak	✓	✓	✓	✓	—	—	—	—
	Honey Oak Honey Oak	✓	✓	✓	✓	—	—	—	—
	Iron Oak Iron Oak	✓	✓	✓	✓	—	—	—	—
	Nature Oak Nature Oak	✓	✓	✓	✓	—	—	—	—
	Pearl Oak Pearl Oak	✓	✓	✓	✓	—	—	—	—
	Smoked Oak Smoked Oak	✓	✓	✓	✓	—	—	—	—
	Vanilla Oak Vanilla Oak	✓	✓	✓	✓	—	—	—	—
	Harvest Oak Harvest Oak	✓	✓	✓	✓	—	—	—	—
	Ivory Oak Ivory Oak	✓	✓	✓	✓	—	—	—	—
	Riga Amber Riga Amber	✓	✓	✓	✓	—	—	—	—
	Riga Terracota Riga Terracota	✓	✓	✓	✓	—	—	—	—

	Decor Branco White Decor Decor Blanc	✓	✓	—	—	—	—	—	—
	Lacado Branco White Lacquered Laqué blanc	✓	✓	—	—	—	—	—	—
	Alumínio anodizado Anodized alum. Alum. anodisé	—	—	✓	✓	✓	✓	✓	✓

A reprodução de cores é meramente ilustrativa podendo variar a sua tonalidade para a amostra física do produto.

(EN) The color reproduction is merely illustrative and its tone may vary from the real product.

(FR) La reproduction des couleurs est simplement illustrative et son ton peut varier du le produit réel.

FAUS

TEMPO 
1350 x 210 mm



PAVIMENTO

Flooring | Revêtements de sol

Carvalho Alhambra
Alhambra Oak | Chêne Alhambra

Carvalho Asta
Asta Oak | Chêne Asta

Carvalho Bermont
Bermont Oak | Chêne Bermont

Carvalho Champagne
Champagne Oak | Chêne Champagne

Carvalho Lavanda
Lavanda Oak | Chêne Lavanda

Carvalho Maset
Maset Oak | Chêne Maset

Carvalho Matiz
Matiz Oak | Chêne Matiz

Carvalho Miranda
Miranda Oak | Chêne Miranda

Carvalho Pasión
Pasión Oak | Chêne Pasión

Carvalho Selección
Selección Oak | Chêne Selección

Carvalho Taupe
Taupe Oak | Chêne Taupe

Carvalho Victorian
Victorian Oak | Chêne Victorian

Nogueira Italiano
Italian Walnut | Noyer italien



RODAPÉS E PERFIS DE REMATE

Skirtings and Profiles | Plinthes et Profils

  Harvest Oak



  Iron Oak



  Honey Oak



  Carvalho Branco
White Oak | Chêne Blanc



  Iron Oak



  Vanilla Oak



  Blond Oak



  Blond Oak



  Iron Oak



  Harvest Oak



  Honey Oak



  Nature Oak



  Nogueira
Walnut | Noyer



FAUS

COSMOPOLITAN (AC5)
1350 x 210 mm



PAVIMENTO

Flooring | Revêtements de sol

Carvalho Lisboa
Lisboa Oak | Chêne Lisboa

Carvalho Oslo
Oslo Oak | Chêne Oslo

Carvalho Venecia
Venecia Oak | Chêne Venecia

Carvalho Viena
Viena Oak | Chêne Viena



RODAPÉS E PERFIS DE REMATE

Skirtings and Profiles | Plinthes et Profils

  Nature Oak

  Nature Oak

  Pearl Oak

  Iron Oak

Padrões limitados ao stock existente.
Colors limited to existing stock.
Couleurs limitées au stock existant.

Carvalho Berlín
Berlín Oak | Chêne Berlín

Carvalho Londres
Londres Oak | Chêne Londres

Carvalho Milán
Milán Oak | Chêne Milán

Carvalho Moscú
Moscú Oak | Chêne Moscú



Carvalho Paris
Paris Oak | Chêne Paris

Carvalho Tokio
Tokio Oak | Chêne Tokio

COSMOPOLITAN 4V 1350 x 210 mm

(AC5)

  Iron Oak

  Nogueira
Walnut | Noyer

  **Carvalho Antiqua**
Antiqua Oak | Chêne Antiqua

  Golden Oak

  Decor Branco
White decor | Decor blanc

  Alumínio anodizado
Anodized alum. | Alum. anodisé

  Nature Oak

  Iron Oak



A reprodução de cores é meramente ilustrativa podendo variar a sua tonalidade para a amostra física do produto. A presente correspondência trata-se de uma sugestão de combinação dos padrões mais aproximados. Contudo existem sempre as opções GS FLOORS: Decor Branco, Alumínio anodizado e Prata II, compatíveis com quase todos os padrões de pavimentos.

(EN) The color reproduction is merely illustrative and its tone may vary for the real product. The present correspondence is a suggested combination of the closest colors. However, there are always the GS FLOORS options: White Decor, Anodised Aluminum and Silver II, compatible with almost all flooring patterns.

(FR) La reproduction des couleurs est simplement illustrative et son ton peut varier pour le produit réel. La correspondance actuelle est une combinaison suggérée des motifs les plus proches. Cependant, il existe toujours les options GS FLOORS : Decor Blanc, Aluminium anodisé et Argent II, compatibles avec presque tous les motifs de revêtements de sol.

www.finfloor.com
FINfloor

EXITUS (AC5)
1331 x 194 mm



PAVIMENTO
Flooring | Plancher

Carvalho Andover
Andover Oak | Chêne Andover

Carvalho Cartago
Cartago Oak | Chêne Cartago

Carvalho Liverpool
Liverpool Oak | Chêne Liverpool

Carvalho Malta
Malta Oak | Chêne Malta

Carvalho Perla
Perla Oak | Chêne Perla

Carvalho Sarela
Sarela Oak | Chêne Sarela

Carvalho Sibéria
Sibéria Oak | Chêne Sibéria

Carvalho Tejo
Tejo Oak | Chêne Tejo

Carvalho Tobacco
Tobacco Oak | Chêne Tobacco

Carvalho 1.2
1.2 Oak | Chêne 1.2

Faia 1.2
1.2 Beech | Hêtre 1.2

Jatoba Douro
Douro Jatoba | Jatoba Douro

Pinho Lima
Lime Pin | Pin Lime

Nogueira Majestic
Majestic Walnut | Noyer Majestic

Sucupira
Sucupira | Sucupira



RODAPÉS E PERFIS DE REMATE
Skirtings and Profiles | Plinthes et Profils

	Olmo Escuro Dark Elm Orme foncé	
	Arizona Oak	
	Harvest Oak	
	Harvest Oak	
	Blond Oak	
	Iron Oak	
	Golden Oak	
	Decor Branco White decor Decor blanc	
	Alaska Oak	
	Nature Oak	
	Nogueira Walnut Noyer	
	Carvalho nº 2 Nrº 2 Oak Chêne nº 2	
	Faia Beech Hêtre	
	Mogno Mahogany Acajou	
	Carvalho nº 2 Nrº 2 Oak Chêne nº 2	
	Nogueira Walnut Noyer	
	Sucupira Sucupira Sucupira	

www.finfloor.com
FINfloor
ORIGINAL AC5
1200 x 189 mm



PAVIMENTO
Flooring | Plancher

Carvalho Bromo
Bromo Oak | Chêne Bromo

Carvalho Chic
Chic Oak | Chêne Chic

Carvalho Calcic
Calcic Oak | Chêne Calcic

Carvalho Columbia
Columbia Oak | Chêne Columbia

Carvalho Glamour
Glamour Oak | Chêne Glamour

Carvalho Obelisque
Obelisque Oak | Chêne Obelisque

Carvalho Paramount
Paramount Oak | Chêne Paramount

Carvalho Retro
Retro Oak | Chêne Retro

Carvalho Titanium
Titanium Oak | Chêne Titanium

Carvalho Vintage
Vintage Oak | Chêne Vintage

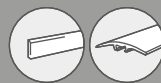

RODAPÉS E PERFIS DE REMATE
Skirtings and Profiles | Plinthes et Profils

	Iron Oak	
	Decor Branco White decor Decor blanc	
	Alumínio anod. Aluminium Anodized anodisé	
	Decor Branco White decor Decor blanc	
	Alaska Oak	
	Arizona Oak	
	Olmo Escuro Dark Elm Orme foncé	
	Carvalho RW RW Oak Chêne RW	
	Alumínio anod. Aluminium Anodized anodisé	
	Nature Oak	
	Nogueira Walnut Noyer	
	Harvest Oak	
	Iron Oak	
	Teka	



Rodapés
Skirtings | Plinthes



Perfis de remate
Profiles | Profils

Padrões limitados ao stock existente.
Colors limited to existing stock.
Couleurs limitées au stock existant.

A reprodução de cores é meramente ilustrativa podendo variar a sua tonalidade para a amostra física do produto. A presente correspondência trata-se de uma sugestão de combinação dos padrões mais aproximados. Contudo existem sempre as opções GS FLOORS: Decor Branco, Alumínio anodizado e Prata II, compatíveis com quase todos os padrões de pavimentos.

(EN) The color reproduction is merely illustrative and its tone may vary for the real product. The present correspondence is a suggested combination of the closest colors. However, there are always the GS FLOORS options: White Decor, Anodised Aluminum and Silver II, compatible with almost all flooring patterns.

(FR) La reproduction des couleurs est simplement illustrative et son ton peut varier pour le produit réel. La correspondance actuelle est une combinaison suggérée des motifs les plus proches. Cependant, il existe toujours les options GS FLOORS : Decor Blanc, Aluminium anodisé et Argent II, compatibles avec presque tous les motifs de revêtements de sol.



Rua do Olival, 499- Marrazes 2415-527 Leiria - PORTUGAL
GPS N 39.76262º | W 8.81559º
geral@gosimat.pt www.gosimat.pt

Telf. +351 244 882 596
+351 244 849 210

Fax. +351 244 881 318
Telm. +351 919 728 210



A **GS FLOORS** reserva-se o direito de alterar ou eliminar, total ou parcialmente, qualquer gama, referência ou especificação técnica contida neste catálogo.

*The **GS FLOORS** reserves the right to change or remove all or part of any range, reference or technical specifications contained in this catalog.*

***GS FLOORS** réserve le droit de modifier ou de supprimer, en tout ou en partie, quelque'une gamme, référence ou spécification technique contenues dans ce catalogue.*